

An Autonomous Water Vapor Plume Tracking Robot Using Passive Resistive Polymer Sensors

S. Kazadi*, R. Goodman, D. Tsikata, D. Green†, H. Lin‡

October 19, 1999

Caltech Microsystems Group
136-93 Moore Labs
Pasadena, Ca 91125

Abstract

A simple reactive robot is described which is capable of tracking a water vapor plume to its source. The robot acts completely within the plume and is endowed with no deliberate information about wind direction or speed, yet accurately tracks the plume upstream. The robot's behavior, results from the behavior of simple resistive polymer sensors and their strategic placement on the robot's body.

keywords: olfactory plume tracking, autonomous robot, resistive polymer sensors

1 Introduction

An odor plume is a coherent structure made up of concentrated packets of odorant. These odor packets move outward from their source, carried by a combination of fluid current and diffusion. Moreover, they are sometimes very dispersed in space, and sometimes tightly packed. Plumes are sometimes located in fluid that is quite turbulent or whose flow speed is much quicker than the speed of diffusion. In these cases, only their time averaged behavior is predictable.

Tracking a plume to its source is a difficult task, as it is highly affected by the turbulence of the media and by the sensitivity of the sensors to both the media and other odorants in the media. In air, a sensor that is quite sensitive is often times quite slow, and may exhibit hysteresis or a changing baseline in the presence of the odorant in question. An autonomous agent tracking a plume to its source is required to use one or both of the time-averaged behavior of the plume or its instantaneous concentration to locate the source. When the agent moves quite slowly, its sensors may be very slow without affecting the algorithm, and so sensitive sensors may be preferred, despite their speed. However, when an autonomous robot moving through air is used to track plumes in real time, the signal must be available and stable in a matter of tens to hundreds of milliseconds, depending largely on the scale of the plume and the speed of the robot.

Once a sensor has been built that is sufficiently fast and reliable to be able to track plumes in real time, the algorithm that tracks the plume must be built. This algorithm must be able to handle the effects of

*To whom correspondence should be addressed.

†Currently attending Delaware State University.

‡Currently at University of California, Berkeley.

turbulence, which include large regions of space with no odorants, intermittent signals, and packets with different properties. It is important to learn what information is necessary for the search, and to make use of this information efficiently, adding extra information only when necessary. While it is true that odor plumes are macroscopic structures made up of microscopic odorant packets, and that each packet's physical properties provide information that may be used in a search algorithm, we must decide what information to use and how to use it.

In general, most attempts at plume tracking have used the "PC on board" philosophy. The assumption is that a great deal of processing is required to extract enough data to track a plume, as the data used by biological systems (Grasso, 1996) may be quite detailed and subtle. Data ranging from edge detection to gradient calculations might be used to track plumes. The "PC on board" approach has the advantage of making it easy to prototype different schemes quickly, as the strategy may be programmed conveniently and tested. However, this requires the robot to carry a load of computational equipment that can be cumbersome and complex, and may not be more effective than simple analog circuitry with minimal controllers; it is not clear that extensive computation is required to lead a robot to an odor source. Rather, it is postulated that a simple reactive robot might be capable of tracking an odor to its source, requiring neither explicit memory nor formal computation.

In this paper, we describe a simple robot made with extremely simple circuitry. This circuitry is based on simple combinatorial logic, and contains no explicit state or memory and no internal processing of sensory data. The robot simply reacts to external environmental conditions. However, the robot is capable of tracking an odor plume reliably upstream, and has a surprisingly high success rate from anywhere within the plume, and any initial configuration. In Section 2, we describe previous work on autonomous olfactory search and some of the enabling technologies. In Section 3, we describe the sensors our robot is using. In Section 4, we describe the robot itself. In Section 5, we give the results of several trials in air using a single robot and pair of sensors, explaining the ability of the robot to track an odor plume to its source by understanding the properties of its sensors. Finally, in Section 6, we offer some concluding remarks.

2 Previous Work

A growing body of work is available which describes partially or fully autonomous robotic systems carrying out olfactory tracking. In general the state of the art seems to be partially autonomous robotic systems, and emphasis is usually placed on the search itself, not its termination. Indeed, there is no specific consensus on which details of the plume structure and dynamics are useful; this is a topic of current research. Thus, it is not surprising that there are a large number of strategies for plume tracking. One might argue that the number of strategies one might find or try is as varied as those found in nature, a very large number of strategies indeed!

2.1 Enabling Technologies

A number of olfactory technologies are available for use in plume tracking system. In systems where speed of search is not an issue, one may use very slow olfactory technologies. In systems in which the speed of search is an issue, one finds that sensitivity is often traded off for speed, something that is not generally a problem in biological systems. A number of different technologies have been developed, ranging from purely artificial systems to remarkable fusions of real biological technology and artificial technology. We do not attempt to

be encyclopedic, but rather to give a brief flavor of what has been built.

An interesting odor recognition system has been constructed by Russel et. al. (Russel, 1995). In this system, a quartz crystal is used as a primary odor recognition device. This has the ability to change its intrinsic properties due to external conditions. Thus, when treated externally with a chemical which preferentially holds onto other volatile compounds, and then exposed to some or all of these compounds, the resonance frequency of the crystal will change, indicating the presence of at least one of the compounds of interest.

This system has a simple implementation and it is capable of being very accurately tuned due to the resonance properties of the crystal. The transduction of the signal obtained by the crystal is nearly instantaneous. Finally, depending on how the crystal is coated, the sensor may be either broadly or narrowly tuned.

Despite these advantages, however, the system has a serious disadvantage. In order to function properly, the sensor must be coated with a substance that attracts the odorant of interest. This coating, in order to be sensitive needs to be able to hold enough of the odorant to change the resonance properties of the crystal. However, this can make the reaction of the sensor slow, and so unsuitable for use in an autonomous robotic system.

A second type of technology makes use of the properties of polymers. Many polymers react to different odorants in a variety of interesting ways. These effects may manifest themselves as changes in the conductance, the density, the tensile strength, etc. of the polymer. These may be used in a number of interesting ways, from changing the index of refraction of the polymer to changing its size or conductive properties. Doping allows the last two to be coupled in non-conducting polymers.

Polymer-based sensors have a number of desirable properties. These are broadly tuned, and many have reproducible responses to low odorant concentrations. In many cases, these sensors are very quick to respond fully to an odorant, and can reach equilibrium in tenths of seconds. Finally, polymers may be applied to a number of surfaces, making the development of specialized sensors built into uncommon parts of the robot simple. Thus, polymers may be applied to parts of the robot commonly used to probe difficult-to-reach areas of the robot's world.

The main limitations of polymer sensors also derive from their physical structure. Polymers are long chains of repeated units. When these chains break, the properties of the polymer change, including their sensitivity to some substances. This change is irreversible, giving the sensors a finite lifetime that may depend on the chemicals they encounter and the odorant concentrations they are exposed to. Polymer sensors seem to have a limited responsiveness. This responsiveness changes as the polymers encounter different environments. Indeed, the optimal environment for a polymer sensor may be one which is climate controlled, and isolated from the rest of the world. Some labs are attempting to develop such systems on mobile robots, but the work is in its infancy¹. Some sensors require doping in order to produce conductive pathways. This adds complexity to the sensor, as the dopants themselves may have nontrivial properties.

Some sensors derive from biological systems themselves. In some ways, they represent the most ideally suited sensors. These sensors are extremely sensitive, but are typically very specific to particular substances, such as pheromones.

In an elegant study, Kuwana and colleagues (Kuwana, 1995) removed the antennae from a male silk moth (*Bombyx mori*) and installed them on an autonomous mobile robot. These sensors were then used to

¹An example of two places in which this type of control goes on are the Lewis group in the Chemistry Department at the California Institute of Technology, and Cyrano Sciences, a company recently formed to develop polymer olfactory sensors.

carry out a variety of different algorithms for plume tracking. As the sensors were shown to have activity proportional to the concentration of the odorant (female pheromones), both edge tracing algorithms, and gradient-based algorithms could be used. The beauty of these sensors is that they are already engineered for a variety of environments commonly encountered by the moth, and need no further engineering. One drawback is that they cannot be further engineered, and so their properties are unalterable, barring any genetic engineering or related work.

2.2 Tracking Strategies

Along with the different types of sensors come different types of search strategies. These strategies are widely varied, and each strategy is dependant on the particular olfactory technology available. As the dependence is quite strong, the group defies classification, except in two areas. The first is the set of strategies that use wind direction, and second is the set that doesn't. A possible subgroup is that which uses dynamic properties of the odorant packets sensed by the robot. However, only one group (Grasso, 1996) has reported the possible use of this. Airborne plumes typically move too quickly to make use of this data.

2.2.1 Strategies Utilizing Wind Direction

The most successful strategies in plume tracking are those that utilize wind direction information. This piece of information is so important, that the lack of it can be the main reason for failure. Despite the great need for this piece of information, the way in which it is obtained can vary widely. Moreover, the accuracy of this information is less of a critical issue than one might expect, and four directions can normally suffice for good performance, though only two need be used.

Russell et. al. (1995) report on the design of a robot which is capable of tracking a camphor plume upwind to its source. In these experiments, the wind direction is used in conjunction with gradient information. Assuming that the robot can reliably determine the center of the plume by following a gradient to the center of the plume, the robot's two behaviors include acquisition of an approximate center of the plume by determining the differential concentration at two crystal-based sensors spaced apart, and the following of the plume upwind, as determined by an on-board wind vane. An obstacle avoidance behavior was included by adding a sensitive bumper to the system and forcing the robot to make on-the-spot turns when it came into contact with an obstacle, effectively avoiding it. The robot was capable of reliably tracking the plume and avoiding obstacles from a meter away.

Ishida et. al. (1996) describe a robotic system in which an 'active probe' is constructed. This 'active probe' uses a fan to draw air to the sensor, effectively handling the boundary layer problem², and the difficulty associated with a limited amount of available odorant. Wind direction information is obtained by rotating this sensor by 360° and recording that direction which has the largest reading. Later versions included stationary directional sensors fabricated from four sensors arranged in a cross, providing quicker but less accurate direction information. The new design could also be used to find three-dimensional plume information, though this information was generally unused.

²The *boundary layer problem* refers to the tendency of an odorant to pass over a sensor without directly interacting with it. This is a serious problem when dealing with odorants whose presence is intermittent or sporadic.

2.2.2 Strategies Without Wind Direction

The simplest algorithm for determining the position of the plume source is one employed by Kuwana et. al. (1996) in which the robot remains completely within the plume as it is carrying out its tracking behavior. The robot is inactive when outside of the plume, and active when inside the plume. Its behavior is simple, forcing the robot to execute turns when it approaches the edge of a plume, and to walk straight when completely within the plume. This strategy has two main weaknesses. Firstly, the robot cannot find the plume, but rather must be initially placed within the plume in order for it to function at all. Secondly, half the time the robot will tend to go downstream, and half upstream. A bad turn produced by noisy or unexpected sensor data might cause the robot to move in the wrong direction down the plume.

A similar algorithm may be used to track saline plumes in water. Grasso et. al. (1998) report the construction of a robotic ‘lobster’ designed to track saline plumes in water. The robot is endowed with sensors which can determine the local concentration of saline. Using this information, the robots climb a concentration gradient from the plume source. The speed of each motor is controlled by the sensed concentration of the salt in the water. Turns can then be affected by changes in the concentration. The robot, which initially moves from within the plume, will also employ a backing behavior if the concentration becomes too low, indicating that the plume has been exited.

2.3 The Mystery

The algorithm developed and employed as part of this study is identical in design to that developed by Kuwana et. al. (Kuwana, 1996). As with their model, the expected behavior is to remain within a plume and walk upstream or downstream, bouncing back and forth from edges of the plume, with equal probability of walking in either direction. The observed behavior, however, is quite different from that expected. In actuality, the robot executes turns often, preferentially moving upstream, and finding its way to the odor source 70% of the time, regardless of initial direction. Herein lies the mystery which inspired this study. Clearly some property of the sensors and/or circuitry biases the robot sufficiently so as to make it likely that in each instance, the robot finds its way to the plume source. The challenge is to understand the mechanism.

3 Description of the Sensors

An odor sensor must fulfill a number of requirements in order to be useful for robotic olfaction. It must respond differently to a wide variety of odorants. It must be relatively fast on the behavioral timescale of the agent employing it. It must also be lightweight, be robust, and require little power.

In this section, we briefly describe a set of sensors which seem to fulfill these properties. These sensors have another desirable property derived from their physical deposition method – they are sensitive to the direction of wind. In Section 4, we will see that it is this property which leads to the ability of our robot to find an odor plume’s source.

3.1 Resistive Sponges

Sensors used to track odor plumes in air must have the ability to react reliably to airborne odorants. Moreover, they must react to differing intensities of odorants fast enough to allow the robot to react in real time to changing local concentrations of odorant. In addition, the sensors’ range must be sufficiently wide for all regimes of use. This last condition is the most difficult to fulfill in general, as many conventional sensors

with acceptable sensitivities are slow to react and have sensitivities which are dependant on environmental conditions.

A new class of polymer-based sensors has recently been made available (Lewis, 1996, White and Kauer, 1997), and is under development in several laboratories. These sensors react to a variety of different odorants by altering their physical attributes including audio resonances, fluorescence, and conductivity. The degree to which their attributes change depends largely on the identity of the analyte, but is nonzero for large classes of analytes. These sensors are surprisingly robust, generally reactive (or *broadly tuned*), easily fabricated, and may be cobbled into arrays of different sensors allowing individual identification of the odorant in question by making use of the responses (both temporal and absolute) of the different sensors. A variant of this sensor, developed by the Electronic Nose project at Caltech, is a passive reactive resistor whose properties change when interacting with specific classes of analytes. This resistor fulfills the requirements, as it is sensitive when properly fabricated, fast in its response, broadly tuned, and passive.

The Caltech resistors are polymer-based resistors which act as sponges under the influence of specific analytes. Although these polymers react to a wide range of analytes, their responses to each one is variable, providing combinatorial signatures across many polymers. These resistors are doped with carbon black. This doping produces a conductivity much greater than the natural conductivity of the polymer, which is dependant on the absolute density of carbon black in the polymer. When the polymer expands under the influence of an analyte, the carbon black granules are more greatly dispersed, and the conductivity decreases. On the other hand, in response to some analytes, some polymers will contract, and this will tend to increase the conductivity of the polymer. Thus, an analyte may be detected by an increase (or decrease in some cases) in the resistance of the sensor.

In the laboratory, when generating control strategies for robots, one wishes to avoid the complexity of odor identification. One would rather use a simple sensor that reacts reliably to a given odor not normally found in abundance in a laboratory environment. As these experiments are not carried out in a wind tunnel or a lab with a separate air supply for test objects, odorants employed must be easy-to-make and non-toxic substances. Moreover, one would prefer a sensor whose electronic interface is relatively simple. Water-vapor plumes generated with vegetable steamers and fans were used for this study. The sensors used were poly N-vinyl pyrrolidone based resistive sensors. The design and cost overhead for the plume is minimal, and mimics wind-blown odor plumes in natural systems.

In resistive sensors, the dynamic variable is the resistance. This will change in the presence of the object or phenomenon being detected. One attractive element in a polymer-based sensor is its ability to give reliable $\frac{dR}{R}$ ³ readings for identical concentrations of analyte. This allows one to measure the concentration of an analyte no matter the resistance of the sensor. Since fabrication of the sensors is in its infancy, and no two fabricated sensors are identical (within any reasonable tolerances), this is a nice property to base sensor circuitry on. In these experiments, we employ a set of simple four-op-amp-circuits that automatically match the baseline resistance of a given sensor. This baseline can then be compared to the instantaneous resistance, providing a measurement of the analyte concentration change. In our trials, we restrict this to one well-known analyte, assuming that all others have a fairly constant concentration which may be ignored.

³Sensors are characterized by their change in resistance, as the ratio of the change in resistance to the whole resistance is relatively constant when the concentration is low. The aging of the resistors makes measurement of the exact resistance an unreliable measurement.

3.2 Switching Properties of Sponge Resistors

As we shall see, the behavioral properties of the robot are a direct reflection of the properties of its sensors. The sensors exhibit behavior that depends on the direction from which the wind is blowing. In order to understand the behavior of the robot, we must first understand the sensors' behavior thoroughly.

The relevant properties of the sensor to our plume tracking robot are the ability of the sensor to detect airflow, and its dynamic properties in the presence or absence of wind. Most important is the speed with which the signal changes state (i.e. from on to off or off to on).

The speed of wind near and around this sensor is a strong effector of the sensor's adaptation characteristics. In the absence of wind

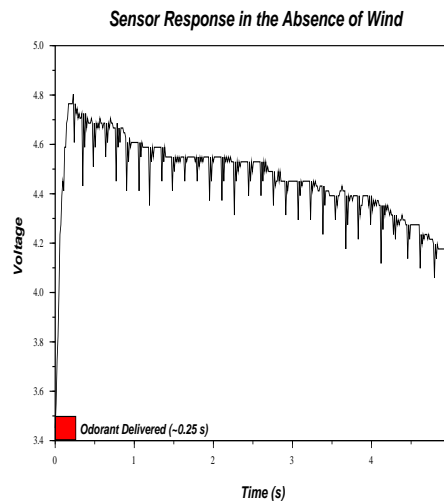

Figure 1: This graph gives the response of a typical polymer-based sensor after a brief exposure to water vapor. Despite a fast increase in sensor resistance, the sensor does not rebound to its previous baseline resistance for tens of seconds. This response is unacceptable for behaving robotic systems.

the sensor quickly (<200 ms) reaches its peak resistance. However, the resistor takes more than ten seconds to return to the baseline once the peak has been reached, and the odor source has been removed (Figure 1). In the presence of wind the situation changes, and the baseline resistance is recovered more quickly. The same resistor placed just outside of a wind stream produced by a fan with an airspeed of ~ 0.5 m/s, displays a behavior

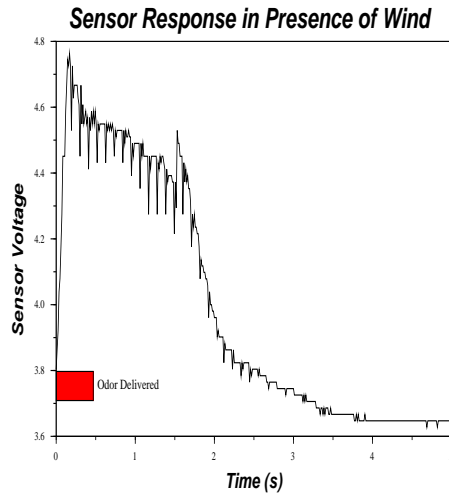

Figure 2: This graph gives the response of a typical polymer-based sensor after a brief exposure to water vapor in a system with sustained airflow. The sensor's resistance much more quickly rebounds to its baseline value. This response is fast enough to be useful for behaving robotic systems.

in which the baseline resistance is quickly recovered (Figure 2).

This dependence on the presence of wind is a key factor. The fast response allows one to use simple thresholding circuitry to determine whether or not an analyte is present. In its absence, we would need to determine the time-dependant derivative of the sensor response in order to determine whether or not we are currently sensing the odor; we would also require one bit of memory indicating the state of the boundary we just crossed.

The sensor's properties are not only dependent on the presence of wind, but also on the direction of wind with respect to the face of the sensor. As sensors are coated with the polymer/carbon black solution only on one side, this is expected⁴. This effects both primarily the decay rate after presentation of an odorant. In two typical responses, a sensor facing upwind (Figure 3) will have a decay rate which is less than half that of the same sensor facing downwind (Figure 4).

⁴Wind directly impinging on the sensor face will tend to increase the rate at which odorant is removed, while that impinging on the other side will also increase the rate, but to a lesser degree.

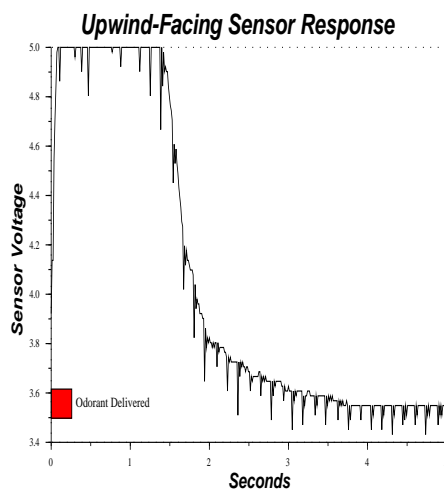

Figure 3: This graph gives the response of a typical polymer-based sensor facing upwind, and located in the wind stream. The resistance increases rapidly with the onset of the odor signal, and decrease rapidly with its removal.

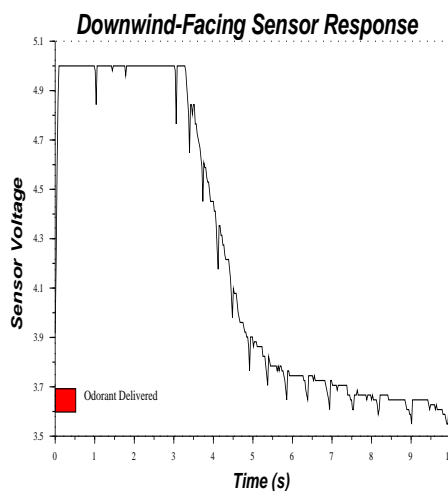

Figure 4: This graph gives the respons of a typical polymer-based sensor facing downwind. This particular measurement is from the same sensor that produced the upwind response shown in Figure 3. Note that the time required to fall back to baseline is more than twice that of the previous sensor. This indicates that the sensor's response is dependant on its orientation in the stream.

Typically, the time required for sufficient odorant to off-gas, returning the sensor's resistance to its baseline value, is longer when the sensor is facing downwind than when it's facing upwind. This property arises because the polymer is deposited on only one side of the printed circuit board. The polymer absorbs the analyte quickly, with a correspondingly fast rise time, but does not release it as quickly. The fall time is more than twice that observed with the sensor facing upwind. In this case, the sensor has a two second fall time rather than a one second fall time when the sensor is facing upstream. Concomitantly, as one might expect, the rise time, while being fast, is still not equal to that observed with the sensor facing upwind.

4 Description of the Robot

In this section, we describe the robot used in the development of our plume tracking algorithm. The robot is built using a toy chassis developed and marketed by the Elekit company as part of a kit designed to provide a hands-on introduction to robotics (Figure 5). This particular chassis is ideal as it is inexpensive, simple to use, and walks. The robot is powered by two nine volt batteries, which provide reliable power for a half an hour behavior.

This system has two severe drawbacks. First, the motors are simple DC motors with poor quality control. That is, no two motors seem to rotate at identical or comparable speeds in any kit. This produces a 'limp', making the robot trace out a large circle, rather than follow a linear track, as designed. The second drawback is the very limited space available in its cargo bulb, making the circuits by necessity, small and simple. This limitation drives the design of simple analog circuits with limited processing, and led to the development of the simple strategy to be discussed.

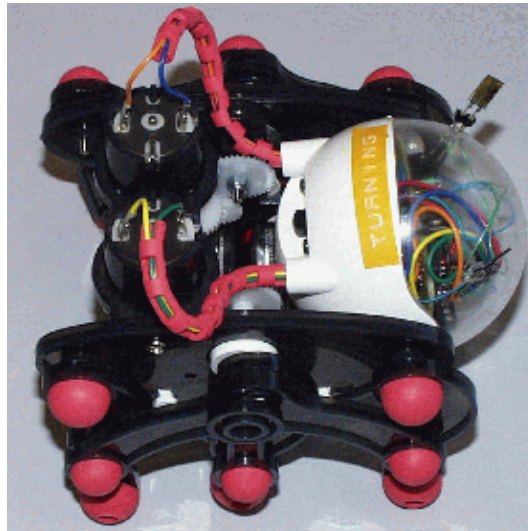

Figure 5: This robot, built from a toy kit produced by the Elekit company, contains only two sensors oriented at a 90° from each other, with their mid-angle located along the robot's apparent line of motion. The robot is powered by two DC motors, each controlling one set of 'legs', and has a simple combinatorial logic controlling these motors.

Each sensor is fabricated as described in Section 2. It consists of a printed circuit board with two conductive leads between which the polymer/carbon black solution has been deposited. Each sensor is oriented with its coated side facing 45° from the direction of forward motion of the robot, and oriented 90° from the other sensor. It is partially occluded from behind or the side by the robot's cargo bulb.

The resistance is read via a voltage divider, and compared to an adaptive voltage which represents the time-averaged sensor reading. The circuit is given in Figure 6.

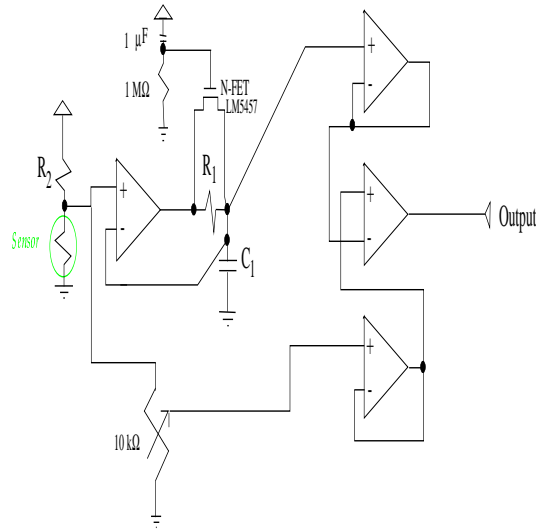

Figure 6. This is the sensor circuitry of the robot. The robot consists of two sensors, each with this circuitry. The output of the two circuits is fed into combinatorial logic, which determines the control signals for the motor driver. The circuitry consists of three parts: a voltage divider, a slow voltage follower, and a comparator. This provides binary sensor information, enough for this algorithm to succeed.

This sensor circuitry consists of three major parts. The first part is a voltage divider made up of the sensor, which is essentially a variable resistor. The sensor resistance varies with the concentration of odorant – linearly at low concentrations – and with substance being detected.

The second part of the sensor circuitry is a slow voltage follower. The capacitor charges through a $10\text{ M}\Omega$ resistor, making the time for charging (discharging) extremely long, depending on the value of the capacitor. In our experiments, we used a $47\ \mu\text{F}$ capacitor, making the time constant 470 sec, a long time on the time scale of the robot’s actions. By contrast, typical resistance changes of the resistor were greater than a 100% change, and could be occur completely in 0.1 – 0.2 sec. This means that the voltage measured at the capacitor is virtually unchanged for complete resistance cycles which take a matter of seconds. On the other hand, lasting changes in the baseline resistance of the sensor, which would persist indefinitely⁵, would be ‘followed’ by the slow voltage follower, providing an accurate measurement of the time-averaged behavior of the sensor.

The third part of the sensor circuitry is a comparator, which compares a ratio of the voltage across the sensor with that at the capacitor. The ratio is chosen to be small enough that the sensor noise does not sporadically trigger a false sensor signal. A signal, which is reflected by a rise in the voltage across the sensor, will cause the comparator to register a higher voltage across the sensor, and so the arrival of an odorant is registered. The comparator output is then fed into a PAL, which decodes the four possible states, and generates motor control signals.

The robot’s behavior is based on four possible sensor states, and is determined by the current state. It does not employ any explicit memory in the generation of an action. The four possible sensor states and corresponding behaviors are given in Table 1.

⁵These sensors tend to have a monotonically increasing baseline resistance. The cause of this resistance increase is not known.

Sensor Signals	Robot Behavior
No signals.	Do nothing.
Left sensor signal.	Turn right.
Right sensor signal.	Turn left.
Both sensors signal.	Move forward.

Table 1: The four sensor states (left), each correspond to a unique behavior. These states are determined entirely by the current sensor state of the robot, and is not determined in any way by the previous state of the robot.

Although this strategy does not process any information about the robot’s current state or history, it is capable of keeping the robot within the plume. The robot is at an edge when one sensor is on and the other off. The robot then executes a turn, walking back into the plume. There is no explicit directionality built into this design, however.

5 Trials

The robot was run through several trials in a simple plume generated in the laboratory. We now describe the trials and performance of the robot in our system.

5.1 Plume Generation

The robot described above was tested in a plume made from off the shelf parts, in an attempt to include as much turbulence and noise in the plume itself as in a realistic case. In order for a robot to work essentially off-the-shelf and in a wide variety of climates and situations, it must have the ability to work in a less controlled environment than that available in a wind tunnel. Thus, our plume was generated in open air from a steam source.

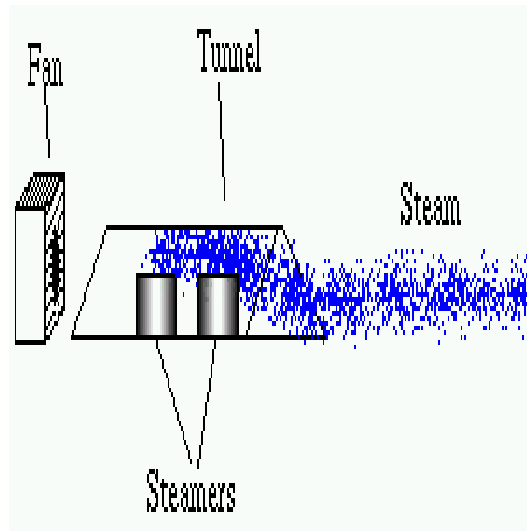

Figure 7: This figure gives a schematic view of our plume generator. The generator consists of two steamers within a columnating “tent” and a fan which blows the air both through the “tent” and around the “tent”.

Figure 7 gives the design of our plume generating system. It comprises of two vegetable steamers inside a small columnating “tent”. In our trials, the “tent” is made of Plexiglas, although we have had success using paper, cardboard, and wood, in the same configuration. A single fan generates an ambient wind speed of ~ 0.5 m/s, and is at one end of the “tent”, pushing the steam out the other side. Figure 8 shows a plume being generated using this apparatus.



Figure 8: This is a picture of our apparatus and a steam plume it generated.

The steam plume has nontrivial structure, as it is generated in a medium of differing temperature. Moreover, the quantity of steam produced by the steamers varies widely, despite continuous operation of the steamers. While the heat has artificially increased the amount of water vapor in the air, this plume is qualitatively similar to other “leaky” plumes.

The plume has a well-defined concentration gradient which extends both across the plume axis and along it. Using the sensors described in section 2, we are able to measure contours of average plume concentration. Commensurate with Grasso et. al., we find that the plume consists of two regions. The near region consists of high concentration odorant, whose concentration falls off sharply at the edges of the plume, and whose average concentration decreases as one proceeds downstream. As one proceeds downstream, the plume expands, and the edges become less sharply defined. The time-averaged concentration decreases smoothly while the instantaneous concentration becomes highly variable. Despite this, the time-averaged plume remains well defined over several meters.

5.2 Robot Trials

Several trials were run during which the robot was placed in the plume and allowed to behave. These trials were begun at twenty different positions located within the plume. These positions were located at intervals of one foot both across the plume and downstream along the plume axis. Each row consisted of five positions. Thus, the robot’s initial positions covered two feet across the plume, and four feet downstream. At each position, twenty trials were run. Four initial orientations of the robot were employed: upstream, downstream, and each direction transverse the flow direction. The robot was allowed to behave for ninety

seconds, during which the aperture of the “tent” would either be located (the robot entered the aperture), or the run would be declared a failure.

Our data is given in Figure 9. Along the plume center axis, as many as 80% of the runs were successful.

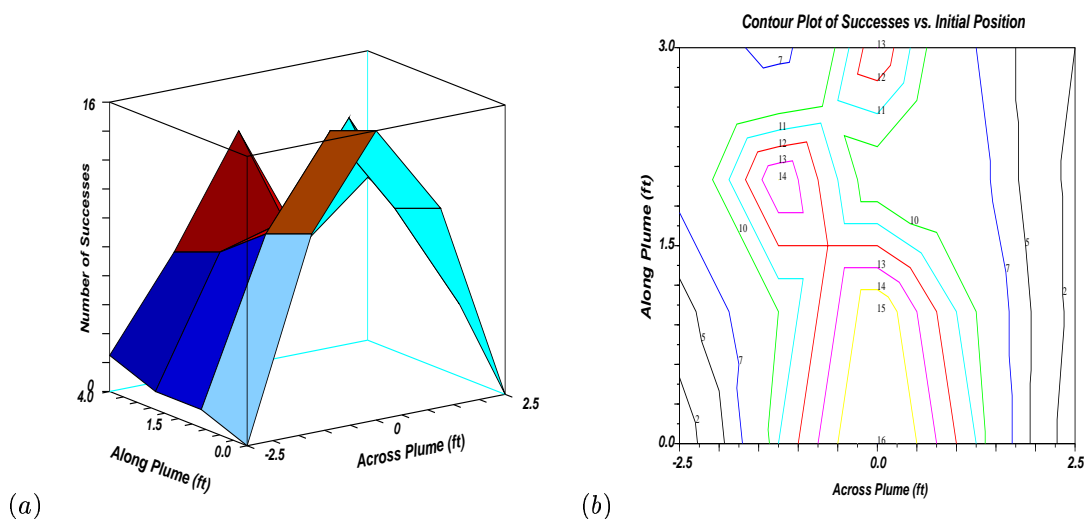

Figure 9: This data gives the number of successes (of all initial orientations) of the robot from differing initial positions. Interestingly, within the plume, the number of successes is quite high, and is surprisingly constant both upstream and downstream. The general shape of the peaks follows the plume structure, as determined independently using the same sensors and visual inspection. The data indicates that the plume is not straight, but rather curves downstream, a reality that was verified after inspection of this data. Each of the contour levels represents the physical boundaries within which we expect to have that number of successful trials, given the twenty total trials.

The success of the individual run is weakly dependent on the initial orientation of the robot⁶. This indicates that the ability of the robot to locate the source was not heavily affected by its initial orientation, but is rather a result of the long-term behavior of the robot. Notably, the behaviors that led the robot to the source occurred only at the edges, as no turns other than the built in “limp” of the robot occurred while the robot traversed the plume.

Interestingly, as the robot’s initial position is moved further downstream, the robot seems to have an increasing tendency to be successful in finding the source when its perpendicular distance from the plume axis is greater. This is commensurate with the expectation that further downstream, the plume will spread out widthwise.

During our trials, two general behaviors were observed which tended to bring the robot to the source when it was headed downstream.

1. The robot would approach a boundary and turn upstream, despite facing downstream at the time.
2. The robot would turn directly upstream from its given spot, and walk directly toward the plume.

⁶The number of successes for each initial orientation also exhibited this gross profile, but has not been included due to the small number of trials with any given initial orientation. No significant statistical conclusion can be drawn from such a small sample.

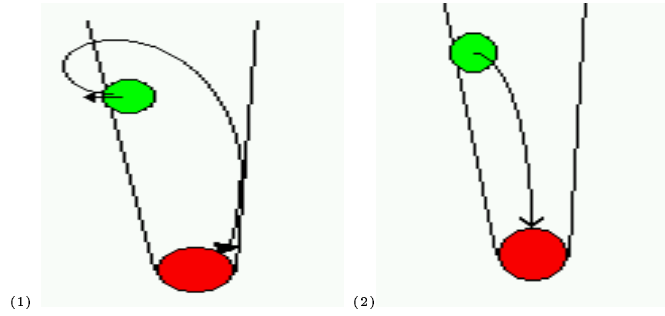

Figure 10: These are two general behaviors that brought the robot to the source. The first behavior (1) would be a wide turn upstream, where a downstream turn is expected, and the second (2) is an upstream turn near or at a boundary.

Both unexpected behaviors were observed commonly during robot runs. As these behaviors are not part of the robot’s design, their surprising emergence requires explanation. As our electronics is quite simple and understandable, this behavior must have its root in the sensors’ intrinsic properties.

Recall that the polymer sensors may be conceptually understood as sponges capable of absorbing specific analytes from the fluid in which they are placed. While these sponges are capable of quickly adsorbing analytes, they have a much lower tendency to release analytes once they are adsorbed. The probability is dependant on the concentration of analyte in the surrounding medium. Thus, as the air speed is increased, hence increasing the ability of the air to remove the analytes surrounding the polymer, the ability of the polymer of off-gas analytes increases.

As the polymer’s off-gassing behavior is heavily influenced by wind traveling over it, the increased resistance may be retained over a long period of time when ambient wind is blocked. Thus, a resistor leaving the plume, which should normally return to a low resistance quickly, may retain its high resistance when the robot blocks the wind that otherwise would remove odorant from around the sensor. It may also retain its high resistance if the sensor itself is facing downstream. Moreover, when a sensor enters the plume and is again facing downstream, or is in the “shadow” of the robot, it may not turn on until it is out of the robot’s “shadow” and/or facing upstream again, depending on the local concentration of odorant.

We can now understand why the robot turns upstream so readily when placed in the plume. Note again that both sensors are placed at 45° from the direction of travel. This means that when the robot is facing downstream by less than 45° , the upstream sensor is facing upstream. Moreover, the downstream sensor is facing directly downstream, making its dynamics considerably slower than the other sensor. In this scenario, the downstream sensor’s resistance will return to baseline more slowly than the upstream sensor’s *even when the downstream sensor leaves the plume first*. This will, in turn, cause a turn of type one, leaving the robot facing upstream.

The second type of unexpected turn is of type two. This turn is caused by the upstream sensor turning on before the downstream sensor turns on. Note that while the robot is not facing directly upstream, the downstream sensor is partially or completely occluded by the robot in addition to simply facing downstream. This makes the upstream sensor turn on exclusively, and the robot will turn. Note that this does not happen in all trials. It would seem that the occlusion is only partly successful, and in 70% of trials, both sensors will turn on, making the robot move directly forward.

Failures of the robot are generally of two classes.

1. The robot could not detect the plume and stopped downstream. The robot would occasionally sporadically spin in both directions as a single sensor was triggered.

2. The robot walked completely out of the plume.

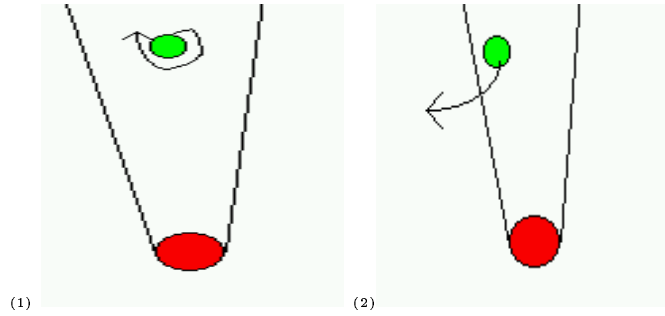

Figure 11: These are two behaviors that signalled the failure of a robot during any given trial. The first (1) behavior is an intermittent rotation of the robot, caused by intermittent sensation of the plume. This could be caused by the autobaseline of the sensor, or by the plume dissipation far downstream. The second behavior (2) is the loss of the plume due to the robot walking out of the plume. This often happened when the robot's batteries were fresh, making the robot move faster than its sensors could react.

The first failure is caused by the robot losing the plume as it walks too far downstream to reliably detect the plume. The second failure is caused by the robot walking out of the plume, and out of the airflow. As the robot leaves the airflow, the slow reaction of the sensors is recovered, and allowing the robot to walk too far out of the plume to reacquire it. Of the two types of failures, this one dominates with 70% of failures being of this type.

6 Conclusions

We have illustrated plume tracking behavior using an extremely simple strategy coupled with a flawed robotic chassis and complicated odor detecting sensors. The simplicity of the algorithm illustrates that it is possible to solve the problem without powerful processing or careful concentration measurements. Rather, it is possible to use only boundary sensing and wind direction information to find the source.

This raises some interesting questions about biological plume tracking. We have an algorithm that is surprisingly robust, and uses no processing power. It is a simple consequence of the physical properties of the sensors being used. In biological systems, similar signalling mechanisms are undoubtedly involved. An adaptive baseline is employed to make gross measurements of odor edges finer, while nulling out sensation after a well-defined sensitive period. It then does not seem surprising that olfactory sensors are active at the boundaries, both temporal and physical, of odors, and less active after a somewhat short exposure to the odor.

We have also illustrated how two important pieces of information, the local wind direction and the plume edge, may be used when tracking a plume to its source. More notably, we have fashioned a robust algorithm out of only these two pieces of information, and have obtained the relevant information from a single sensor. The way that this information is acquired, by physical properties of odor sensors or by mechano-receptors located on hairs on the agent's body does not seem important. A stochastic walk with a higher probability of moving in the right direction will eventually end up at the target. Hence, simple strategies that keep an agent from losing the odorant and at the same time move the agent upstream would seem to be all that are required. The diversity of natural plume tracking systems serves to illustrate this point. These strategies

are largely different, but all seem to include some knowledge of wind direction in quickly moving systems in air. On the other hand, the exact strategy for finding the source varies from species to species. We now believe we understand why information about wind direction is so ubiquitous in search strategies, but any other specific strategy element is not. We would be interested to find a biological agent that uses a similar strategy to that we've illustrated.

Acknowledgements

This work is supported in part by the Center for Neuromorphic Systems Engineering, in part as part of the National Science Foundation Engineering Research Center Program under grant EEC-9402726; and by the California Trade and Commerce Agency, Office of Strategic Technology under grant C94-0165. This work is also supported in part by DARPA/ONR under grant N00014-93-1-0990, and by AFOSR University Research Initiative grant F49620-93-1-0332. This research is also supported by the ONR under grant F49620-97-1-0514, and by DARPA under grant DAAK60-97-K-9503. ONR also provided funding under grant N00014-98-1-0821 Chemical Plume Tracing Via Biological Inspiration and Electronic Olfaction. We also acknowledge support from the DARPA program in Distributed Robotics.

Thanks to Dr. Gurav Sukhatme for his poignant comments and suggestions. Thanks to the anonymous reviewers who took the time to read and point out weaknesses in this work. Their criticism improved the quality of this work.

References

- [1] Dittmer, K., Grasso, F. and Atema, Jelle. 1996. *Obstacles to Flow Produce Distinctive Patterns of Odor Dispersal on a Scale that could be Detected by Marine Animals*, **Biological Bulletin**, 191: 313-314.
- [2] Dittmer, K., Grasso, F. and Atema, Jelle. 1995. *Effects of Varying Plume Turbulence on Temporal Concentration Signals Available to Orienting Lobsters*, **Biological Bulletin**, 189: 232-233.
- [3] Grasso, F., Consi, T., Mountain, D. Atema, J. 1996. *Locating Odor Sources in Turbulence with a Lobster Inspired Robot*, **Proc. 4th International Conference on Simulation of Adaptive Behavior**, Maes, Mataric, Meyer, Pollack, and Wilson (Eds), Cambridge, Massachusetts : MIT Press.
- [4] Grasso, F., Consi, T., Mountain, D. Atema, J. 1996. *Behavior of Purely Chemotactic Robot Lobster Reveals Different Odor Dispersal Patterns in the Jet Region and the Patch Field of a Turbulent Plume*, *Biol. Bull.*, 191: 312-313.
- [5] Grasso, F., Consi, T., Mountain, D., Atema, J. 1998. *Biomimetic Robot Lobster Performs Chemo-orientation in Turbulence Using a Pair of Spatially Separated Sensors: Progress and Challenges*. Submitted to **Journal of Robotics and Autonomous Systems**.
- [6] Ishida, H. et. al. 1996. *Odour Source Localization System Mimicking Behaviour of Silkworm Moth*. **Sensors and Actuators**, 99: 225-230.
- [7] Kuwana, Y., Shimoyama, I., Miura, H. 1995. *Steering Control of a Mobile Robot Using Insect Antennae*. **IEEE/RSJ International Conference on Intelligent Robots and Systems**, Vol. 2. 530-535.
- [8] Kuwana, Y., Shimoyama, I., Sayama, Y., Miura, H. 1996. *Synthesis of Pheromone-Oriented Emergent Behavior of a Silkworm Moth*. **Proceedings of the IEEE/RSJ International Conference on Intelligent Robots and Systems**, 1722-1729.
- [9] Lewis, N. et al. 1996. *Array-Based Vapor Sensing Using Chemically Sensitive, Carbon Black-Polymer Resistors*. **Chem. Mater.** 8:(9) 2298-2312.
- [10] Russell, R. A., Thiel, D., Deveza R., and Mackay-Sim, A. 1994. *A Robotic System to Locate Hazardous Chemical Leaks*. **IEEE International Conference on Robotics and Automation**. 13 (3): 232-239.
- [11] White, J. and Kauer J. 1997. *Generating Sensor Diversity through Combinatorial Polymer Synthesis*. **Analytical Chemistry**, 69:17, pp.3413-3418.